

MILANO

Arclinea

MILANO

Arclinea

ARCLINEA PRESENTA IL FLAGSHIP STORE DI MILANO, UN PUNTO DI RIFERIMENTO ESCLUSIVO DOVE SCOPRIRE LA NUOVA COLLEZIONE ARCLINEA, DISEGNATA E COORDINATA DA ANTONIO CITTERIO.

ARCLINEA PRESENTS ITS FLAGSHIP STORE IN MILAN, THE EXCLUSIVE GO-TO ADDRESS SHOWCASING THE NEW ARCLINEA COLLECTION DESIGNED AND COORDINATED BY ANTONIO CITTERIO.

Un nuovo spazio di 450 mq per raccontare l'identità Arclinea, nei concept cucina più innovativi e nella qualità delle soluzioni tecniche, compositive, estetiche. Via Durini 7 è concepito come luogo espositivo, centro di consulenza e progettazione, ma anche punto d'incontro di professionisti del settore e, in occasione di eventi dedicati, luogo di divulgazione di una nuova cultura del cibo. È la "casa Arclinea" a Milano, che guarda al mondo.

A new 450 m² location that tells the story behind the identity of Arclinea, in the most innovative kitchen concepts and quality of its technical, composition and aesthetic solutions. Via Durini 7 has been designed not only as a display venue and centre for consultancy and planning, but also as a meeting place for sector professionals and, during dedicated events, somewhere that will spread a new culture of food. It is the "Arclinea home" in Milan, looking out on the world.





FOCUS ON SETTINGS 6 PROPOSALS

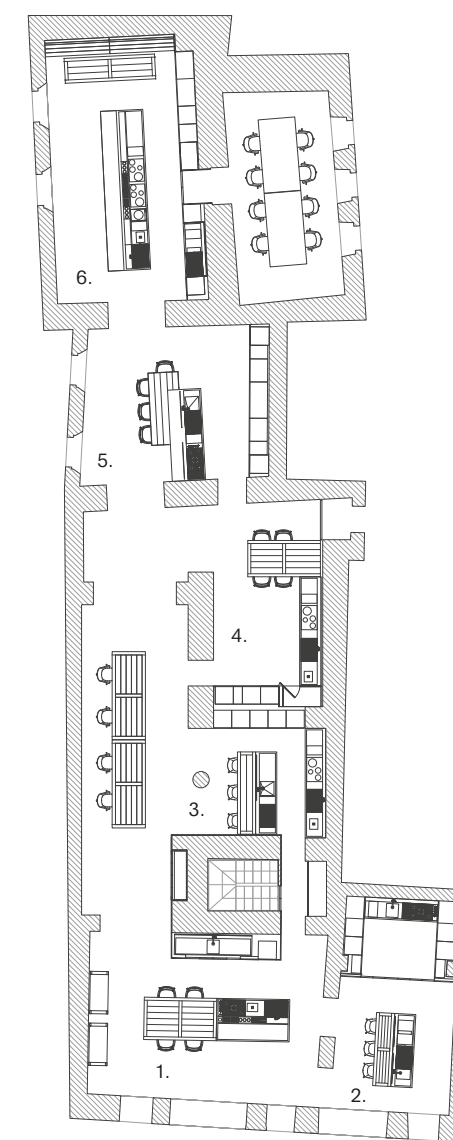

1. CONVIVIUM
2. ITALIA
3. PRINCIPIA

4. CONVIVIUM
5. CONVIVIUM
6. LIGNUM ET LAPIS

Protagonista nell'area d'ingresso è l'isola operativa Convivium con il tavolo integrato Era. A fianco dell'isola una boiserie in legno con ante ad apertura orizzontale Modus disegna un volume architettonico che integra la zona di contenimento e lavaggio. Due diverse soluzioni funzionali della nuova Madia completano l'ambiente. Legno rovere fumé, acciaio inox pvd bronzo e marmo Carrara definiscono lo stile di una soluzione compositiva caratterizzata da elementi distintivi unici, come il piano di lavoro in marmo Carrara con involucro, che accoglie cottura, lavaggio, taglieri in legno, griglie in PaperStone® e al centro il nuovo canale attrezzato in acciaio inox. La cura del dettaglio si evidenzia nel bordo in massello sagomato del tavolo Era, negli esclusivi accessori in filo della zona lavaggio, nelle flessibili e complete attrezzature interne in teak. Particolare attenzione è dedicata all'aspetto illuminotecnico, per i piani di lavoro e per gli interni dei contenitori.

The main player at the entrance is the Convivium work island with Era, the built-in table. Alongside the island, wood panelling with Modus horizontal folding doors designs an architectonic volume that contains the storage and washing area. Two different functional solutions for the new Madia complete this room layout. Fumé oak, bronze pvd stainless steel and Carrara marble set the style for a layout solution characterised by several distinctive elements, such as the worktop in Carrara marble with drip guard for the hob, sink, wooden chopping boards, PaperStone® grids and, in the centre, the new accessorised channel in stainless steel. Attention to detail stands out in the shaped solid wood edging on the Era table, exclusive wire accessories around the washing area, and versatile complete internal accessories in teak. Special care has been taken with the lighting, both for the worktops and the insides of the storage systems.

1. CONVIVIUM











TECHNICAL DATA

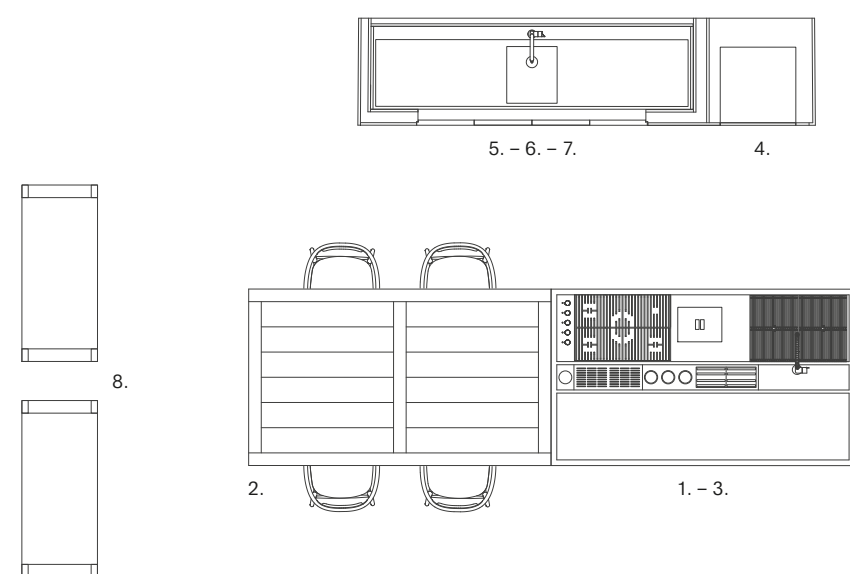

1. **Isola Convivium** 241 x 140 x h 90 cm
ante Convivium Elegant acciaio PVD bronzo
cassetti interni con sponde acciaio, frontale teak
NTF, attrezzati con nuovi accessori
top marmo Carrara h 20 cm con invaso 12 mm
lavello, pattumiera da top, cottura 5 gas Arclinea
con griglie in ghisa, griglie in PaperStone®
e tagliere in legno, entrambi scorrevoli
canale centrale attrezzato in acciaio inox
2. **Tavolo integrato Era** 240 x 140 x h 74 cm
struttura e piano rovere fumè NTF a doghe
bordi perimetrali legno massello
3. **Cappa Convivium**
struttura acciaio PVD bronzo con vetro
perimetrale e luce LED

4. **Volume architettonico**
boiserie rovere fumè NTF a doghe
5. **Modus** larghezza 180,9 cm (4 ante)
ante rovere fumè NTF a doghe
maniglia bronzo
6. **Basi Convivium** 256 x 70 x h 90 cm
ante Convivium acciaio inox PVD bronzo
cassetti interni con sponde acciaio, frontale teak
NTF, attrezzati con nuovi accessori
top marmo Carrara h 8 cm con invaso 12 mm
schienale marmo Carrara
7. **Pensili a giorno** h 36 cm
rovere fumè NTF
profilo LED sotto pensile
accessori in filo nero opaco

8. **Madia free standing** 140 x 60 x h 215 cm
ante Convivium rovere fumè NTF a doghe
MAC contenitore per piccoli elettrodomestici
120 x h 60 cm, interno rovere fumè NTF, luce
integrata, prese elettriche, vassoio estraibile,
cornice in acciaio PVD bronzo e vetro Stopsol
2 forni 60 + 60 cm

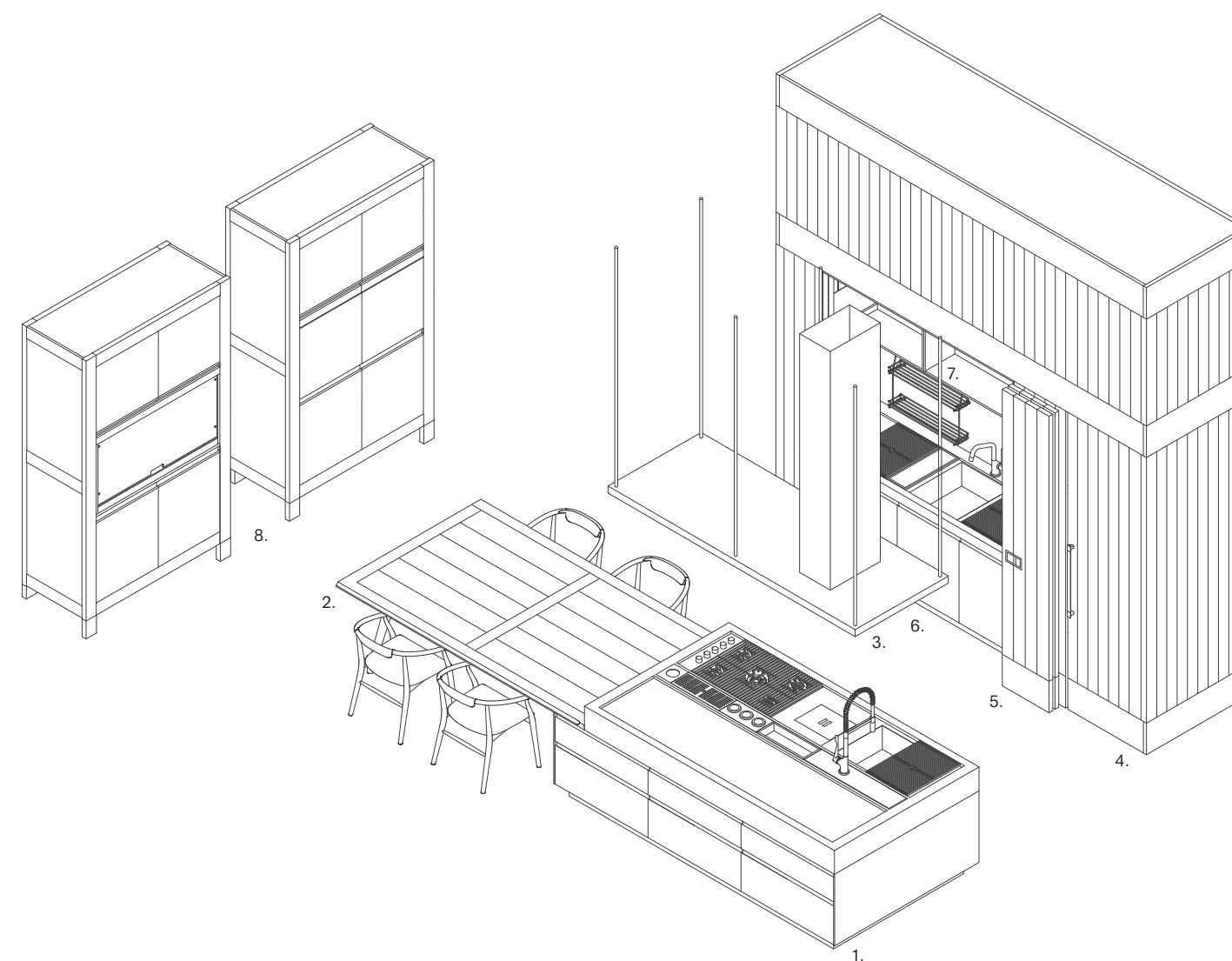

1. **Convivium island** 241 x 140 x h 90 cm
Convivium Elegant doors in bronze PVD steel
internal drawers with steel sides, NTF teak front
and fitted with new accessories
20 cm thick top in Carrara marble, with 12 mm
drip guard
sink, worktop waste bin, Arclinea 5-burner
gas hob with cast iron pan supports, sliding
wooden chopping board and PaperStone® grids,
accessorised central channel in stainless steel
2. **Era built-in table** 240 x 140 x h 74 cm
structure and top in NTF fumè oak slats
solid wood border
3. **Convivium hood**
structure in bronze PVD steel with glass
border and LED lighting

4. **Architectonic volume**
wood panelling in NTF fumè oak slats
5. **Modus** width 180.9 cm (4 doors)
doors in NTF fumè oak slats
bronze handle
6. **Convivium base units** 256 x 70 x h 90 cm
Convivium doors in bronze PVD stainless steel
internal drawers with steel sides, NTF teak front
and new accessories
8 cm thick top in Carrara marble with 12 mm drip guard
Carrara marble back panel
7. **Open wall units** h 36 cm
NTF fumè oak
LED profile for under wall units
accessories in matt black wire

8. **Free-standing Madia** 140 x 60 x h 215 cm
Convivium doors in NTF fumè oak slats
MAC mini appliances container 120 x h 60 cm,
with NTF fumè oak lining, built-in lighting, electric
sockets, pull-out tray, frame in bronze PVD steel
and Stopsol glass
2 ovens 60 + 60 cm

Nello spazio vetrina, una proposta che interpreta le istanze abitative più attuali con un rinnovato desiderio di condivisione e ospitalità. La boiserie in legno teak con ante ad apertura orizzontale Modus separa la cucina interna, concepita per il contenimento e l'operatività, dall'isola esterna, dedicata ai momenti di convivialità. Entrambe le composizioni sono caratterizzate dalla finitura esterna in acciaio inox, sia per le ante che per il piano con vaso, abbinata alla finitura teak degli accessori e degli interni dei contenitori. Diversa la scelta delle attrezzature: cottura a induzione, doppia mensola in acciaio, snack in legno a doghe, vetro para schizzi per l'isola Italia; piano operativo con griglie in ghisa, pattumiera da top, Mensolinea con profilo led e cappa Artusi Gourmet Plus per la composizione Italia all'interno del Closet.

In the store window, an idea that interprets modern lifestyles with a new-found desire for socialising and hospitality. The teak wood panelling with Modus horizontal folding doors separates the internal kitchen, conceived for storage and work, from the external island, perfect for sharing with friends and family. Both layouts are finished externally in stainless steel, both for the doors and the recessed worktop, and this is teamed with a teak finish for accessories and insides of the storage systems. The accessories chosen here are different: induction hob, double steel shelf, snack bar in slatted wood, glass splash guard for the Italia island; worktop with cast iron pan supports and worktop waste bin, Mensolinea shelf with led profile and Artusi Gourmet Plus hood for the Italia layout inside the Closet.

2. ITALIA











TECHNICAL DATA

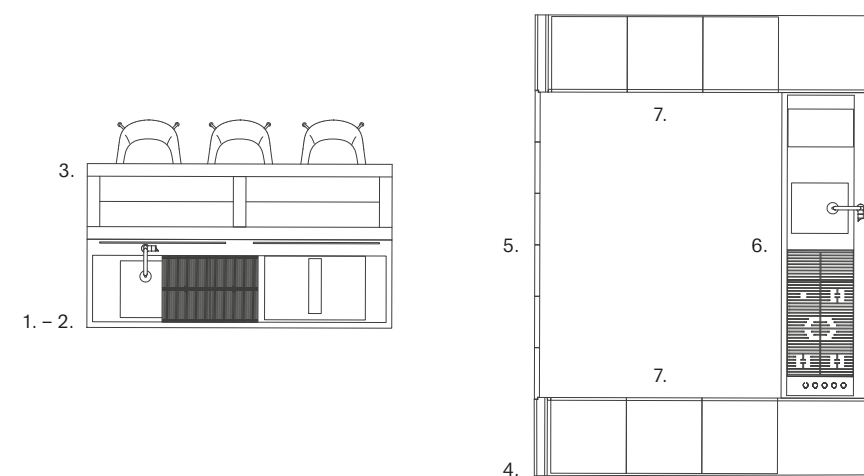

1. **Isola Italia** 242 x 130 x h 92,6 cm
ante maniglia Italia acciaio inox
cassetti interni con sponde acciaio, frontale teak
NTF, attrezzati con nuovi accessori
top acciaio inox h 3,1 cm con invaso 12 mm
e bordo da 6 mm, lavello, piano cottura
a induzione, griglie in PaperStone® e tagliere
in legno, entrambi scorrevoli, vetro para schizzi,
poggia piedi in teak NTF e acciaio inox
2. **Doppia Mensola** 210 x 46 cm
struttura acciaio inox
3. **Snack Era** 242 x 57 cm
piano legno teak NTF a doghe

4. **Boiserie** 364 x h 248 cm
teak NTF a doghe
5. **Modus** larghezza 242,4 cm (6 ante)
ante teak NTF
maniglia acciaio inox
6. **Zona operativa Italia** 244 x 70 x h 92,6 cm
basi sospese con anta maniglia Italia, acciaio inox
cassetti interni con sponde acciaio, frontale teak
NTF, attrezzati con nuovi accessori
top acciaio inox h 3,1 cm invaso 12 mm
e bordo da 6 mm, lavello, cottura 5 gas Arclinea
con griglie in ghisa, tagliere in legno

Mensolinea

finitura acciaio inox, accessori legno teak NTF
profilo LED

Cappa Gourmet Plus profondità 70 cm
struttura acciaio inox e vetro frontale

7. **Colonne attrezzate** 192 + 192 cm
ante con maniglia Italia acciaio inox
frigo, forni, dispensa

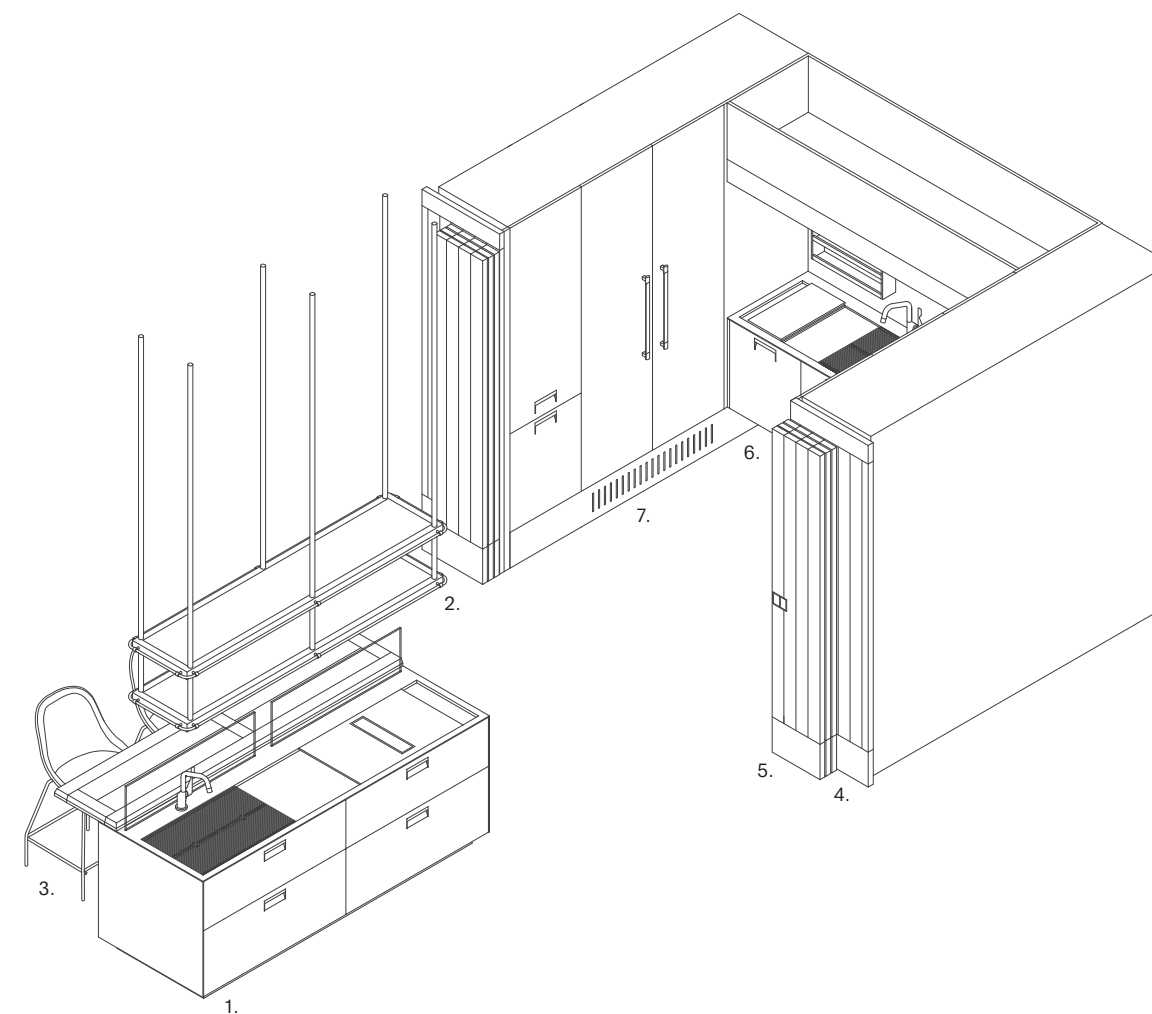

1. **Italia island** 242 x 130 x h 92.6 cm
doors with Italia handle in stainless steel
internal drawers with steel sides, NTF teak front
and new accessories
3.1 cm thick top in stainless steel, with 12 mm
recess and 6 mm edge, sink, induction hob,
sliding PaperStone® grids and wooden chopping
board, glass splash guard, footrest in NTF teak
and stainless steel
2. **Double Shelf** 210 x 46 cm
structure in stainless steel
3. **Era snack bar** 242 x 57 cm
top in NTF teak slats

4. **Wood panelling** 364 x h 248 cm
NTF teak slats

5. **Modus** width 242.4 cm (6 doors)
doors in NTF teak
handle in stainless steel
6. **Italia work area** 244 x 70 x h 92.6 cm
suspended base units with Italia handle doors
in stainless steel
internal drawers with steel sides, NTF teak front
and new accessories
3.1 cm thick top in stainless steel with 12 mm
recess and 6 mm edge
sink, Arclinea 5-burner gas hob with cast iron
pan supports, wooden chopping board

Mensolinea shelf

stainless steel finish, NTF teak accessories
LED profile

Artusi Gourmet Plus hood 70 cm deep
structure in stainless steel glass front

7. **Accessorised tall units** 192 + 192 cm
doors with Italia handle in stainless steel
fridge, ovens, pantry

Un ambiente cucina definito dalla ricerca della massima funzionalità. Al centro, in uno spazio contenuto, l'isola operativa concentra le funzioni di lavaggio e cottura: sul lato opposto un comodo piano snack e nella parte superiore la doppia mensola, sospesa. Sullo sfondo un'area attrezzata per la preparazione: un ampio piano di lavoro con un secondo livello, basi con due cassettoni, pensili con ante in vetro. Le mensole esclusive Arclinea, Mensolinea e Mensoluce, corrono lungo la parete, tra base e pensile, per un'operatività quotidiana efficiente e per avere tutto a portata di mano e di occhi. Raffinata l'estetica del progetto, nella combinazione delle finiture: acciaio pvd nero per le ante Convivium dell'isola, fossil oak per le ante Principia delle basi e della parete attrezzata, granito Nero Assoluto per i piani di lavoro.

A display kitchen that is all about maximum functionality. Cooking and washing are concentrated in the work island that takes up very little room in the centre, which has a handy snack bar on the opposite side and, suspended above it, a double shelf. At the back of the room, an accessorised zone for food prep: a large worktop with a second sink, base units with drawers and glass wall units for storage with, between them, the exclusive Arclinea Mensolinea and Mensoluce shelves. All ensuring efficient everyday use and everything within reach. Aesthetics are enhanced by the special combination of finishes: black pvd steel for the Convivium doors on the island, fossil oak for the Principia doors on the base units and accessorised wall, granite Nero Assoluto for the worktops.

3. PRINCIPIA











TECHNICAL DATA

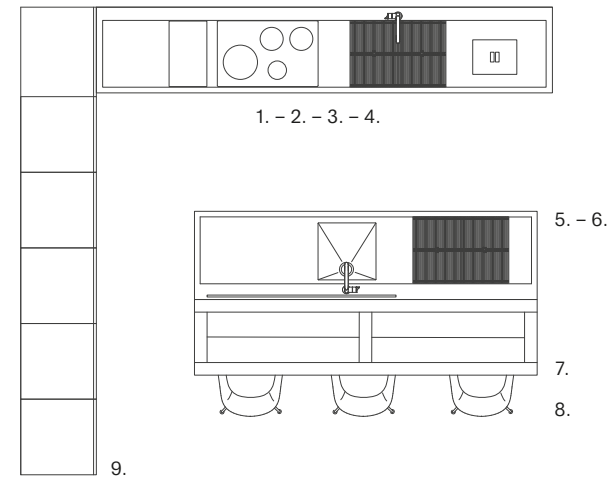

1. **Zona operativa Principia** 362 x 68 cm
ante legno fossil oak NTF
maniglia Principia PVD nero
cassetti interni con sponde inox, frontale teak NTF,
attrezzati con nuovi accessori
top granito lucido Nero Assoluto h 8 cm
con involucro 12 mm, lavello, pattumiera da top,
piano cottura a induzione, griglie in PaperStone®
e tagliere in legno, entrambi scorrevoli
2. **Mensolinea**
struttura alluminio anodizzato nero
accessori scorrevoli in fossil oak NTF
3. **Mensoluce**
struttura alluminio anodizzato nero
4. **Pensili**
interno fossil oak NTF
anta vetro Stopsol retinato
cornice alluminio anodizzato nero

5. **Isola Convivium** 272 x 130 x h 90 cm
anta Convivium acciaio PVD nero
cassetti interni con sponde e frontale nero,
attrezzati con nuovi accessori
top granito lucido Nero Assoluto h 8 cm
con involucro 12 mm, lavello, griglie in PaperStone®
e tagliere in legno, entrambi scorrevoli, vetro para
schizzi, poggiatesta in fossil oak NTF e acciaio inox
6. **Doppia Mensola** 240 x 46 cm
struttura acciaio PVD nero
7. **Snack Era** 272 x 57 cm
fossil oak NTF a doghe
bordi perimetrali in legno massello
8. **Sgabelli Olimpia**
struttura acciaio
schienale e seduta fossil oak NTF

9. **Parete contenitori Principia** 300 x 60 x h 222 cm
ante fossil oak NTF
maniglia Principia PVD nero
luce interna LED a diffusione indiretta
frigo, freezer, forni, dispensa

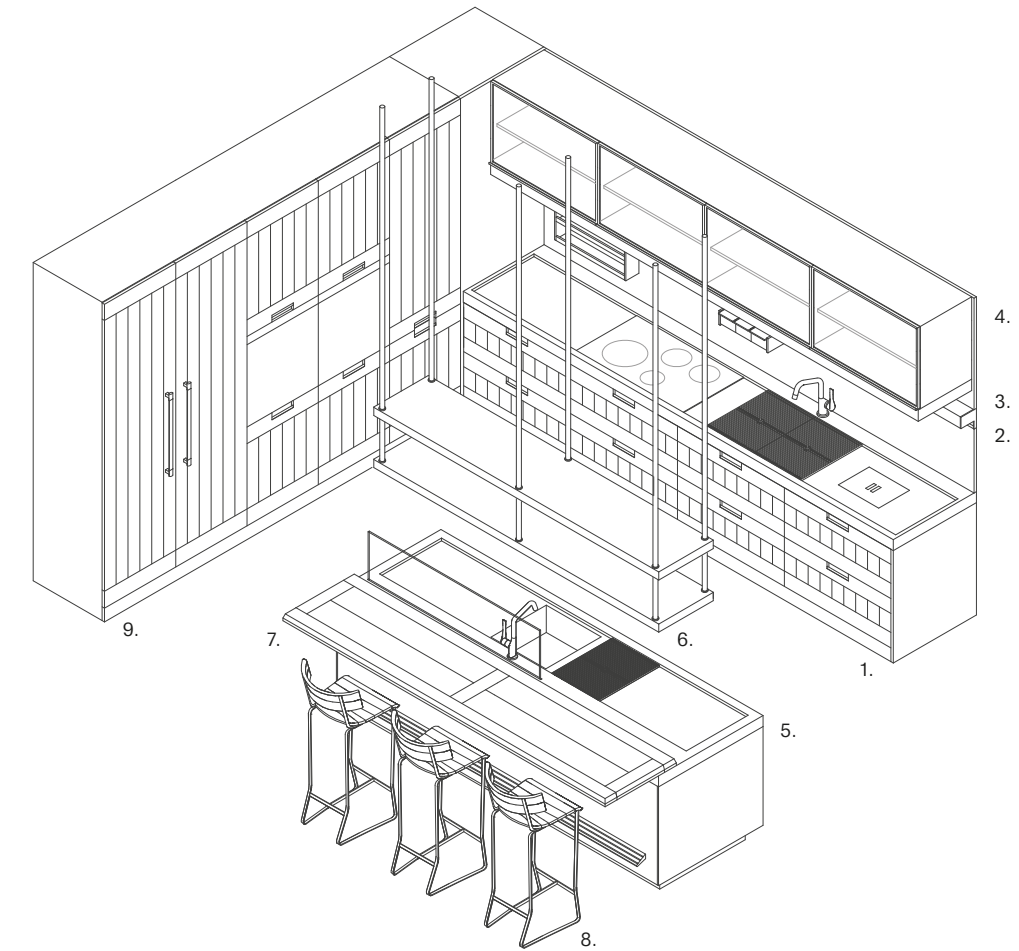

1. **Principia work area** 362 x 68 cm
doors in NTF fossil oak
black PVD Principia handle
internal drawers with stainless steel sides, NTF teak
front and new accessories
8 cm thick top in polished Nero Assoluto granite
with 12 mm drip guard, sink, worktop waste bin,
induction hob, sliding PaperStone® grids and
wooden chopping board
2. **Mensolinea shelf**
structure in black anodised aluminium
sliding accessories in NTF fossil oak
3. **Mensoluce shelf**
structure in black anodised aluminium
4. **Wall units**
lined with NTF fossil oak
wired Stopsol glass door
black anodised aluminium frame

5. **Convivium island** 272 x 130 x h 90 cm
Convivium door in black PVD steel
internal drawers with black front and sides,
new accessories
8 cm thick top in polished Nero Assoluto granite
with 12 mm drip guard, sink, sliding PaperStone®
grids and wooden chopping board,
glass splash guard, footrest in NTF fossil oak and
stainless steel
6. **Double Shelf** 210 x 46 cm
structure in black PVD steel
7. **Era snack bar** 272 x 57 cm
NTF fossil oak slats
solid wood border
8. **Olimpia stools**
structure in steel
back and seat in NTF fossil oak

9. **Principia wall of tall units** 300 x 60 x h 222 cm
doors in NTF fossil oak
black PVD Principia handle
internal diffused indirect LED lighting
fridge, freezer, ovens, pantry

Protagonista dello spazio il legno teak delle pareti attrezzate, del grande tavolo a penisola, dei pensili a giorno; unica interruzione la zona operativa, con ante in laminato Armour bianco, piano di forte spessore e schienale in marmo lucido Portoro. Un materiale, quest'ultimo, che associa un'immagine preziosa a un'estrema praticità d'uso, sottolineata dalla lavorazione del piano ad vaso, che accoglie il tagliere in noce e le griglie in PaperStone[®], entrambi scorrevoli. Nella parte superiore Mensoluce e Mensolinea, le esclusive mensole Arclinea, concentrano diverse funzioni, dall'illuminazione puntuale all'aspirazione dei fumi, fino al contenimento ordinato di piccoli oggetti d'uso quotidiano. Celato, nell'angolo tra le basi e le colonne attrezzate, il Wic, vano walk in closet, con finitura interna in essenza teak e illuminazione con sensore di presenza. Protagonista della proposta l'anta Convivium nella doppia versione Elegant in laminato Armour bianco e New Professional in legno teak con profilo in pvd nero.

The main player in this layout is the teak wood on the accessorised walls, large peninsula table, and open wall units, with the only exception being the work area, its doors in white Armour laminate, thick worktop and back panel in polished Portoro marble. This latter is a material that teams glorious good looks with extreme practicality, highlighted by how the worktop with drip guard is shaped specifically to hold the walnut wood chopping board and PaperStone[®] grids. Various functions are concentrated in the exclusive Arclinea Mensoluce and Mensolinea shelves set above the worktop, from dedicated lighting to fume extraction, through to tidy storage of everyday objects. The Wic, walk in closet, is hidden in the corner between the base units and the accessorised tall units, with internal finish in teak and motion sensor lighting. The main feature of this kitchen is the Convivium door in the double Elegant version in white Armour laminate and New Professional in teak wood edged in black pvd.

4. CONVIVIUM











TECHNICAL DATA

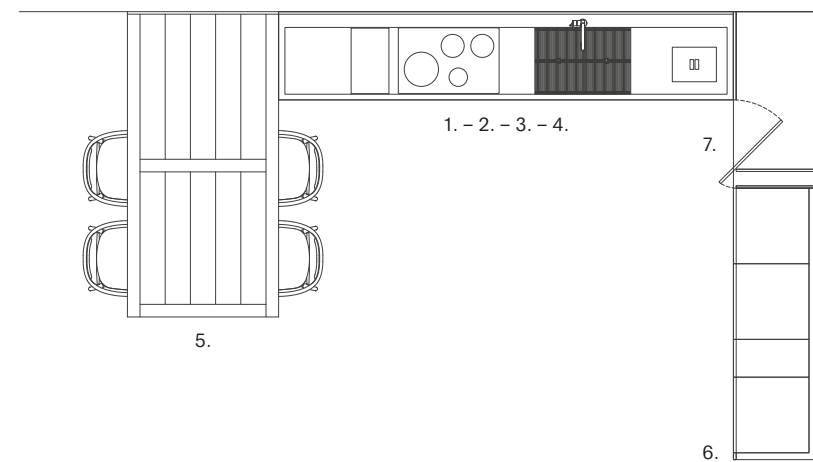

1. **Zona operativa Convivium** 361 cm
ante Convivium Elegant laminato Armour bianco
cassetti interni con sponde inox e frontale teak
NTF, attrezzati con nuovi accessori
top h 20 cm marmo Portoro con invaso 12 mm
lavello, pattumiera da top, piano cottura a
induzione, griglie in PaperStone® e tagliere
in legno, entrambi scorrevoli

2. **Mensolinea** 481 cm
alluminio anodizzato nero
accessori scorrevoli in teak NTF

3. **Mensoluce con cappa** 481 cm
alluminio anodizzato nero
illuminazione LED e cappa integrati

4. **Pensili a giorno** 481 x h 36 cm
teak NTF

5. **Tavolo Era** 240 x 120 cm
struttura e piano teak NTF a doghe
bordi perimetrali in legno massello

6. **Parete contenitori Convivium** 280 x 70 x h 232 cm
ante teak NTF
maniglia New Professional acciaio PVD nero
forni, frigorifero, dispensa

7. **WIC walk in closet** 140 x 70 x h 232 cm
anta e interno teak NTF

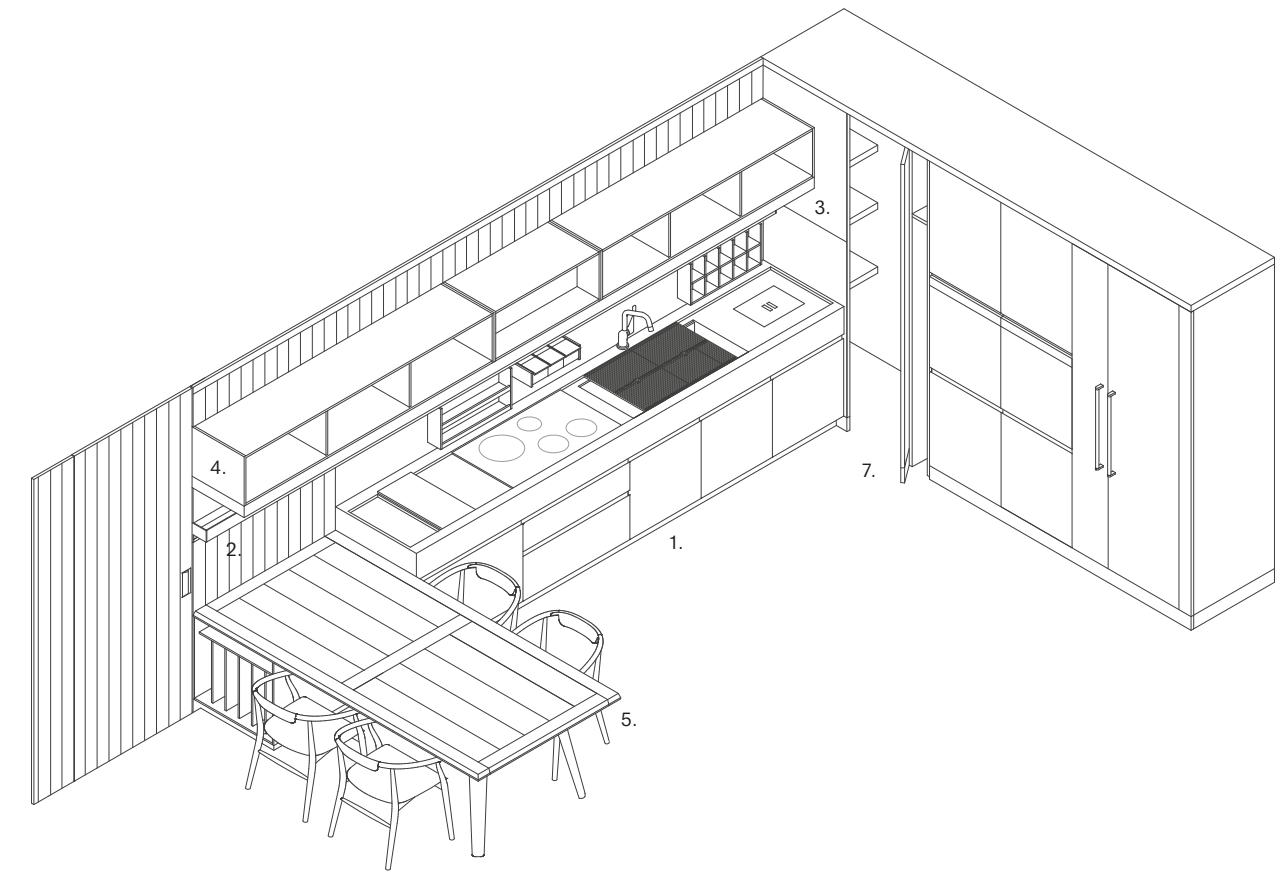

1. **Convivium work area** 361 cm
Convivium Elegant doors in white Armour laminate
internal drawers with stainless steel sides, NTF teak
front and new accessories
20 cm thick top in Portoro marble with 12 mm
drip guard, sink, worktop waste bin, induction hob,
sliding PaperStone® grids and wooden chopping
board

2. **Mensolinea shelf** 481 cm
black anodised aluminium
sliding accessories in NTF teak

3. **Mensoluce shelf with hood** 481 cm
black anodised aluminium
integrated LED lighting and hood

4. **Open wall units** 481 x h 36 cm
NTF teak

5. **Era table** 240 x 120 cm
structure and top in NTF teak slats
solid wood border

6. **Convivium wall of tall units** 280 x 70 x h 232 cm
doors in NTF teak
New Professional handle in black PVD steel
ovens, fridge, pantry

7. **WIC walk in closet** 140 x 70 x h 232 cm
door and lining in NTF teak

Al centro dello spazio un blocco cucina operativo dall'immagine compatta, caratterizzato da un tavolo snack integrato, affiancato da vani a giorno in essenza; sullo sfondo una parete attrezzata con al centro, posizionato tra i due forni, il Mac, mobile con piano estraibile dedicato ai piccoli elettrodomestici. Le finiture, dal legno fossil oak al laminato Armour grigio delle ante Convivium Elegant, fino all'acciaio inox Vintage del piano di lavoro, sottolineano il carattere rigoroso della composizione. Ma sono i dettagli a definire le qualità estetiche e funzionali della proposta: come i cassettei con gola centrale sul lato esterno del blocco cucina e al centro delle colonne, i caratteristici bordi perimetrali inclinati del tavolo snack e l'invaso del piano operativo dedicato alla cottura e al lavaggio, dove posizionare liberamente il tagliere in noce e le griglie in PaperStone®.

In the centre of this kitchen, a compact looking independent unit featuring a built-in snack table, next to open units in wood; at the back of the room, an accessorised wall with two ovens and, between them, the Mac, unit with pull-out top for small electrical appliances. The finishes, from the fossil oak wood to the grey Armour laminate of the Convivium Elegant doors, through to the Vintage stainless steel of the worktop, all highlight the formal feel of this layout. But it is the details that define the aesthetic and functional qualities of this space. Such as the drawers with central grooved handle on the outside of the independent unit and in the centre of the tall units, the characteristic sloping perimeter edges on the snack top and the recess on the worktop for the hob and sink, which also houses sliding walnut wood chopping board and PaperStone® grids.

5. CONVIVIUM









TECHNICAL DATA

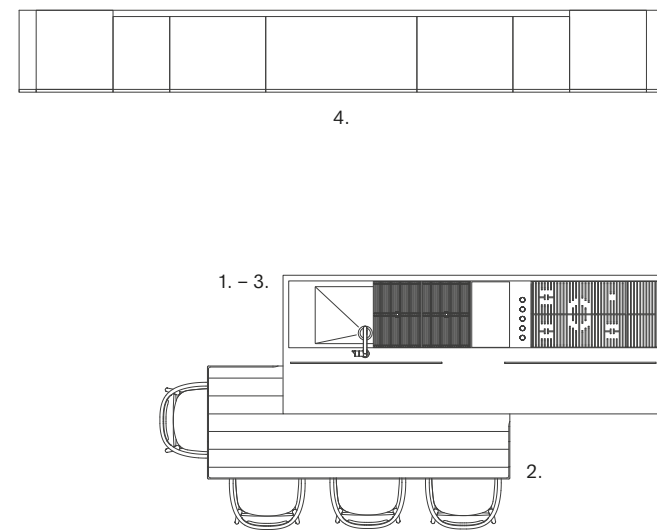

1. **Isola Convivium** 362 x 165 cm
ante Convivium Elegant laminato Armour grigio
cassetti anta con gola, vani a giorno in fossil oak NTF
top acciaio inox Vintage h 3,1 cm con vaso
12 mm e bordo 6 mm, lavello, piano cottura
con griglie in ghisa, tagliere in legno e griglie
in PaperStone®, entrambi scorrevoli, vetro para
schizzi, poggiatesta in teak NTF e acciaio inox
2. **Tavolo snack integrato** 240 x 100 cm
fossil oak NTF a doghe
3. **Cappa Isola** 240 x 90 cm
acciaio inox con vetro perimetrale

4. **Parete contenitori** 511 x 60 x h 237 cm
ante Convivium Elegant laminato Armour grigio
cassetti anta con gola fossil oak NTF e sponde
acciaio, attrezzati con nuovi accessori
MAC contenitore per piccoli elettrodomestici
120 x h 60 cm, interno fossil oak NTF, luce integrata,
prese elettriche, vassoio estraibile, cornice in
acciaio e vetro Stopsol, forni

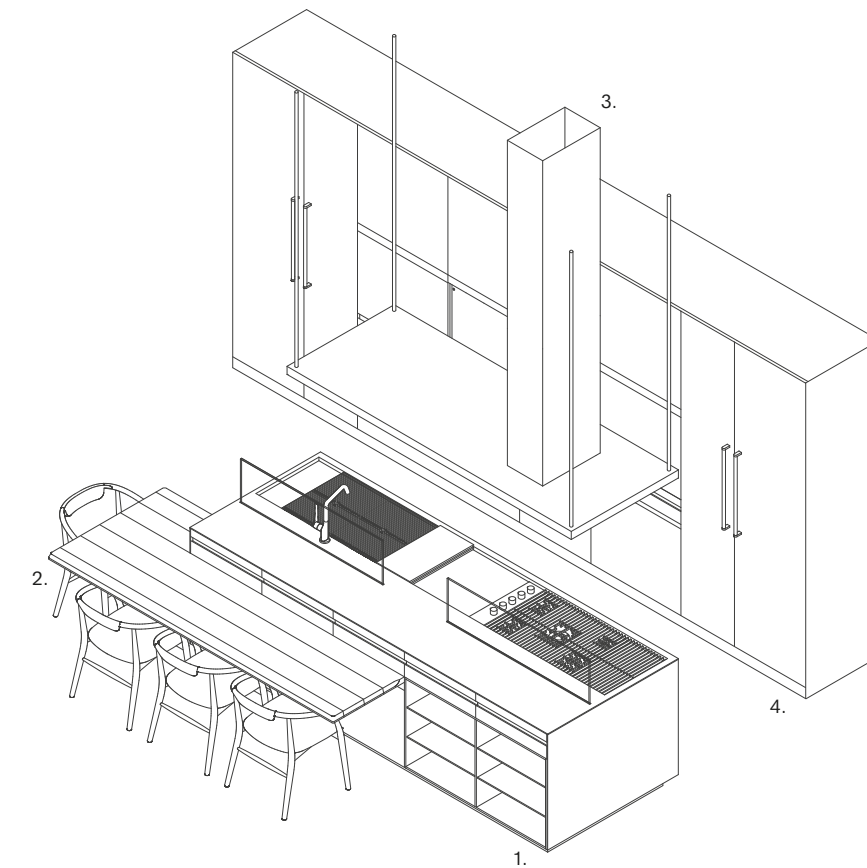

1. **Convivium island** 362 x 165 cm
Convivium Elegant doors in grey Armour laminate
drawers, door with grooved handle, open units
in NTF fossil oak
3.1 cm thick top in Vintage stainless steel, with
12 mm recess and 6 mm edge, sink, induction hob
with cast iron pan supports, sliding PaperStone®
grids and wooden chopping board, glass splash
guard, footrest in NTF teak and stainless steel
2. **Built-in snack table** 240 x 100 cm
NTF fossil oak slats
3. **Isola hood** 240 x 90 cm
stainless steel with glass border

4. **Wall of tall units** 511 x 60 x h 237 cm
Convivium Elegant doors in grey Armour laminate
drawers, door with recessed handle in NTF fossil oak,
sides in steel and new accessories
MAC mini appliances container 120 x h 60 cm, with
NTF fumé oak lining, built-in lighting, electric sockets,
pull-out tray, frame in steel and Stopsol glass, ovens

Un grande spazio operativo, studiato per garantire prestazioni professionali in occasione di eventi Arclinea dedicati allo show cooking. Al centro l'isola Lignum et Lapis: un grande piano ad vaso concentra le funzioni di lavaggio e cottura con pattumiera da piano, griglie in PaperStone® e taglieri in legno noce, entrambi scorrevoli. Il nuovo canale attrezzato centrale separa lo spazio di lavoro dallo snack con inserto in marmo. L'aspirazione dei fumi, fondamentale in uno spazio cucina professionale, è risolta con due grandi cappe Artusi Professional in acciaio inox con vetro perimetrale. Alle spalle dell'isola operativa la parete attrezzata accoglie, oltre ai frigoriferi, ai forni e alla cantina vini, anche un'area funzionale dedicata al lavaggio. Le scelte dell'anta con maniglia incassata Italia e delle finiture acciaio e laminato Armour sono dettate dalla ricerca della massima praticità d'uso.

A large work space, designed to guarantee professional results at Arclinea show cooking events. In the centre, the Lignum et Lapis island: a large recessed worktop houses the hob and sink, a worktop waste bin, PaperStone® grids and walnut wood chopping boards. The new accessorised channel down the middle divides the work space from the snack bar with an insert in marble. Fume extraction, fundamental in a professional kitchen, is guaranteed with two large Artusi Professional hoods in stainless steel with glass border. Behind the work island, the accessorised wall houses not only the fridges, ovens and wine unit, but also a functional washing area. The doors with Italia recessed handle and finishes in steel and Armour laminate have been chosen to ensure maximum practicality.

6. LIGNUM ET LAPIS







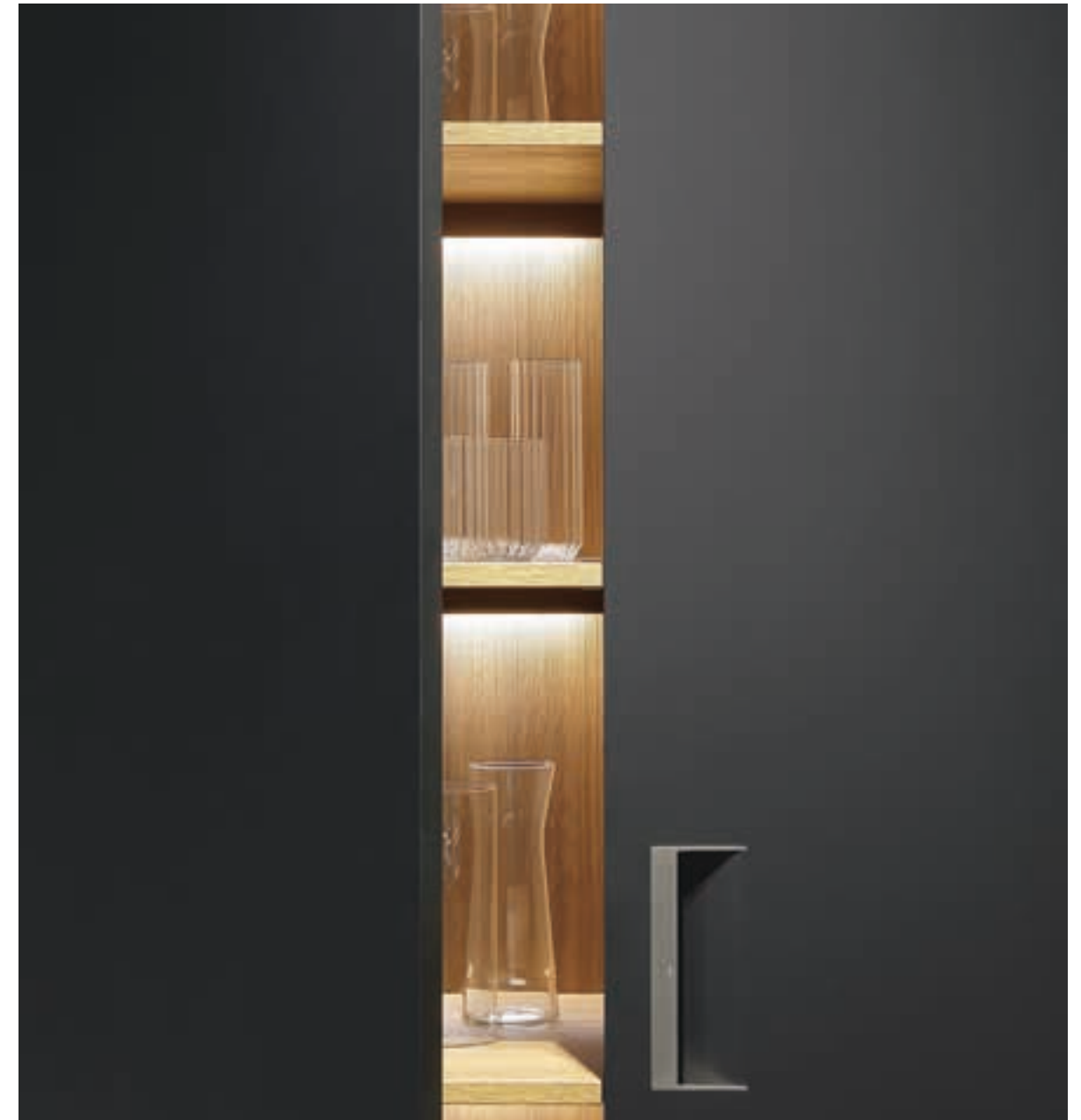



TECHNICAL DATA

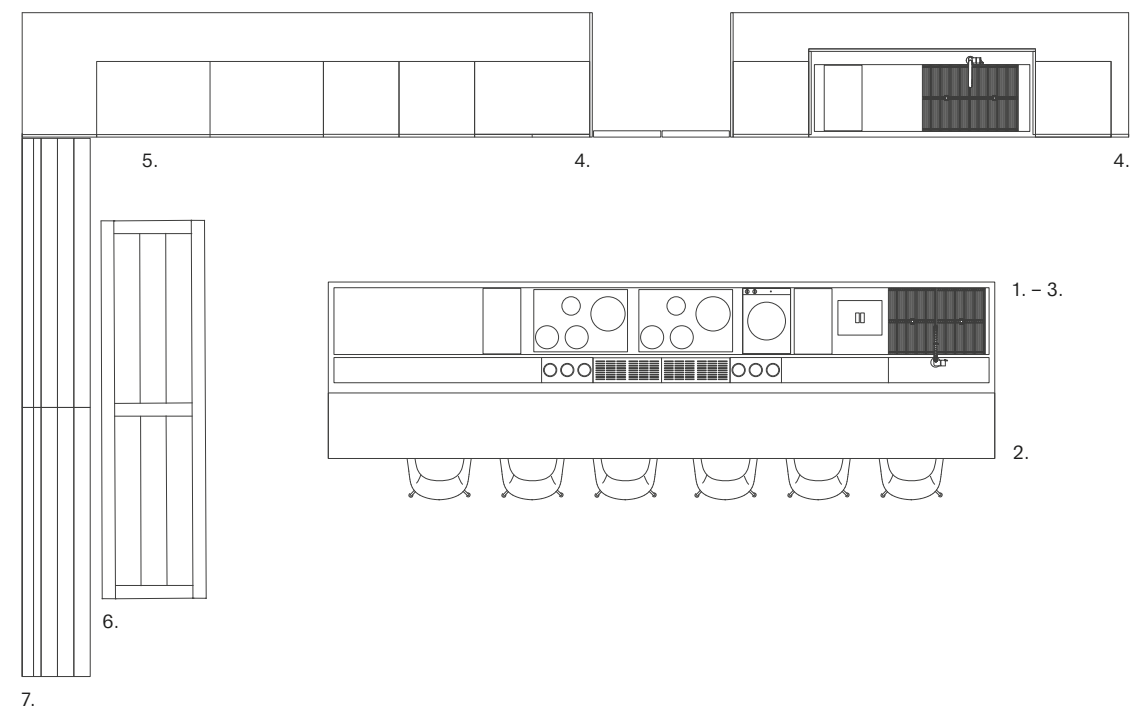

1. **Isola Lignum et Lapis** 529 x 140 x h 94 cm
ante maniglia integrata Italia laminato Armour nero
cassettoni con cassetti interni con sponde,
frontali e fondo nero, attrezzati con nuovi accessori
top in acciaio inox h 12 cm invaso 12 mm
lavello, pattumiera da top, piani cottura a induzione,
tagliere in legno e griglie in PaperStone®, entrambi
scorrevoli, canale attrezzato centrale in acciaio inox,
poggiapiedi in rovere naturale NTF e acciaio inox
2. **Snack integrato**
piano marmo Pietra Grey
3. **Cappe Artusi Professional** 180 x 90 cm
struttura acciaio inox e vetro perimetrale

4. **Parete contenitori**
anta maniglia integrata Italia laminato Armour nero
luce interna LED a diffusione indiretta
top marmo Pietra Grey lucido h 6 cm con invaso 12 mm
lavello, tagliere in legno e griglie in PaperStone®,
entrambi scorrevoli
armadi dispensa, frigo e freezer, forni, abbattitore
5. **Vina & Contenitore** 180 cm
ante complanari
interno rovere naturale NTF

6. **Tavolo Plato Maxalto** 291 x 80 cm
struttura e piano rovere naturale NTF
7. **Panca Arclinea** 410 cm
struttura rovere naturale NTF

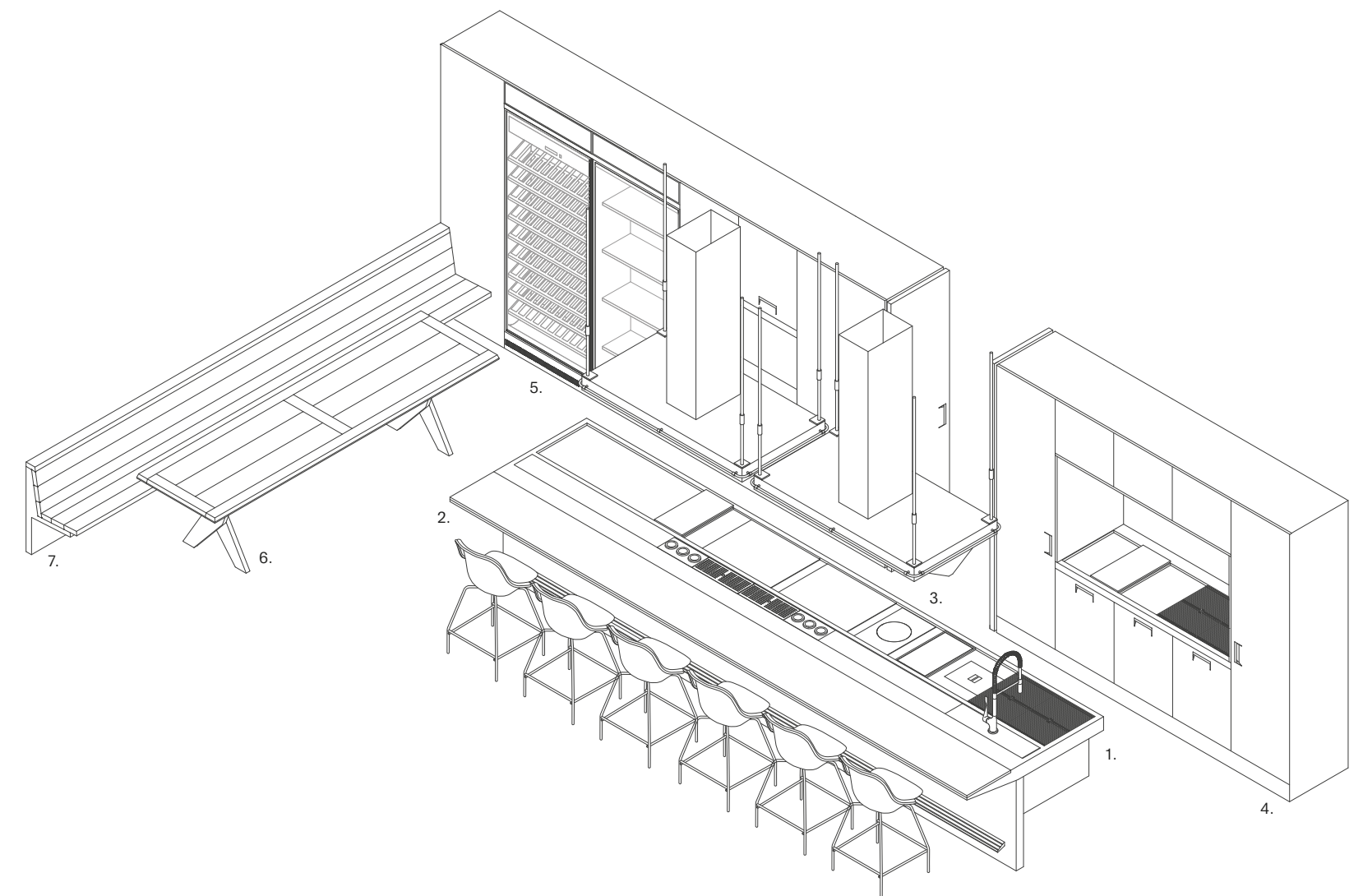

1. **Lignum et Lapis island** 529 x 140 x h 94 cm
door with Italia integrated handle in black Armour
laminato
deep drawers with internal drawers with black
bottoms, sides and fronts and new accessories
12 cm thick top in stainless steel with 12 mm recess
sink, worktop waste bin, induction hob tops,
sliding PaperStone® grids and wooden chopping,
boardscentral accessorised channel in stainless
steel, footrest in NTF natural oak and stainless steel
2. **Built-in snack bar**
top in Pietra Grey marble
3. **Artusi Professional hoods** 180 x 90 cm
structure in stainless steel and glass border

4. **Wall of tall units**
door with Italia integrated handle in black Armour
laminato
internal diffused indirect LED lighting
6 cm thick top in polished Pietra Grey marble with
12 mm drip guard, sink, sliding PaperStone® grids
and wooden chopping board
pantry, fridge and freezer, ovens, chiller
5. **Vina & Contenitore** 180 cm
coplanar doors
lining in NTF natural oak

6. **Plato Maxalto table** 291 x 80 cm
structure and top in NTF natural oak
7. **Arclinea bench** 410 cm
structure in NTF natural oak

Design and coordinated by Antonio Citterio
Store project: studio Tronconi architetti

Graphic design: Juma
Photography: F2 Fotografia
Styling: SimonaSilenziStudio

Postproduction: Diodo
Printing: Grafiche Antiga

September 2018

Arclinea può apportare ai prodotti modifiche, migliorie tecniche, annullamenti di articoli di fine serie che siano ritenuti opportuni, in qualsiasi momento e senza alcun preavviso. | Arclinea reserves the right to modify its products, apply technical improvements or cancel end-of-series articles when deemed opportune and at any time, without prior notice.

COPYRIGHT 2018 ARCLINEA ALL RIGHTS RESERVED.

